

# 41F Sockets

# RELAY SOCKETS



File No.: E253370



File No.: 40020043

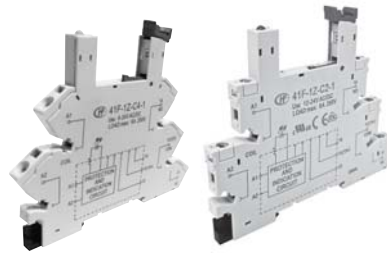

### Features

- The dielectric strength can reach 4000VAC and the insulation resistance is 1000MΩ
- With finger protection device
- Ensure secure retention and easy ejection of relays
- Built-in protection circuit can indicate the power status, protect the circuit and expand the range of relay input voltage
- Components available: marker, jumper and separator
- Applicable relay types: HF41F
- Environmental friendly product (RoHS compliant)

## ORDERING INFORMATION

Type	41F	-1Z	-C2	-1/2/3/4/5
Contact arrangement	1Z:1 Form C			
Termination & mounting	A2: PCB terminal, PCB mounting C2: Screw terminal, DIN rail mounting, With finger protection device C4: Spring-loaded terminal, DIN rail mounting, With finger protection device			
Voltage of module	1, 2, 3, 4, 5: See table above for corresponding information with relay's coil voltage			

## CHARACTERISTICS

Type	Nominal Voltage	Nominal Current	Ambient Temperature	Input Voltage	Relay's Applicable Rated Voltage	Polarity of Input Voltage	Wire Strip Length	Screw Torque	Unit weight
41F-1Z-C2-1	250VAC	6A	-40 °C to 70 °C	(12 to 24)V AC/DC	(12 to 24)V DC	No requirement	7mm	0.5N · m	Approx.27g
41F-1Z-C2-2	250VAC	6A	-40 °C to 70 °C	(48 to 60)V AC/DC	(48 to 60)V DC	No requirement	7mm	0.5N · m	Approx.25g
41F-1Z-C2-3	250VAC	6A	-40 °C to 55 °C	(110 to 125)V AC/DC	60V DC	No requirement	7mm	0.5N · m	Approx.27g
41F-1Z-C2-4	250VAC	6A	-40 °C to 55 °C	(220 to 240)V AC/DC	60V DC	No requirement	7mm	0.5N · m	Approx.27g
41F-1Z-C2-5	250VAC	6A	-40 °C to 70 °C	(6 to 24)V DC	(6 to 24)V DC	Requirement	7mm	0.5N · m	Approx.24g
41F-1Z-C2-5(012)	250VAC	6A	-40 °C to 70 °C	(6 to 24)V DC	(6 to 24)V DC	No requirement	7mm	0.5N · m	Approx.24g
41F-1Z-C4-1	250VAC	6A	-40 °C to 70 °C	(12 to 24)V AC/DC	(12 to 24)V DC	No requirement	7mm	---	Approx.25g
41F-1Z-C4-2	250VAC	6A	-40 °C to 55 °C	(48 to 60)V AC/DC	(48 to 60)V DC	No requirement	7mm	---	Approx.24g
41F-1Z-C4-3	250VAC	6A	-40 °C to 55 °C	(110 to 125)V AC/DC	60V DC	No requirement	7mm	---	Approx.25g
41F-1Z-C4-4	250VAC	6A	-40 °C to 70 °C	(220 to 240)V AC/DC	60V DC	No requirement	7mm	---	Approx.25g
41F-1Z-C4-5	250VAC	6A	-40 °C to 70 °C	(6 to 24)V DC	(6 to 24)V DC	Requirement	7mm	---	Approx.23g
41F-1Z-A2-1	250VAC	6A	-40 °C to 70 °C	(6 to 24)V DC	(6 to 24)V DC	Requirement	---	---	Approx.4g
41F-1Z-A2-2	250VAC	6A	-40 °C to 70 °C	(48 to 60)V DC	(48 to 60)V DC	Requirement	---	---	Approx.4g

**Note:** When the 41F-1Z-C2/C4-1 socket is applied to the relay of 12VDC nominal voltage, the relay of which pick-up voltage =70% nominal voltage should be required and the special order of relay allowed. 41F-1Z-C2/C4-4 is not allowed in continuous electricity conditions.







HONGFA RELAY

ISO9001, IATF16949, ISO14001, OHSAS18001, IECQ QC 080000 CERTIFIED

2021 Rev. 1.00

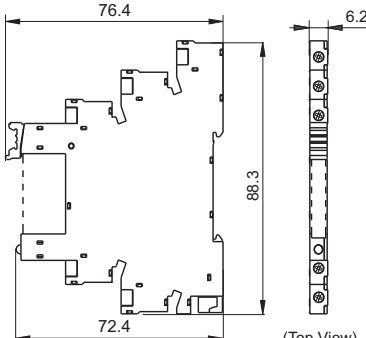
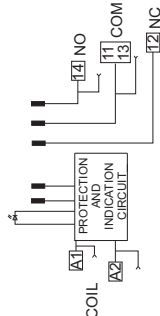
## OUTLINE DIMENSIONS, WIRING DIAGRAM AND PC BOARD LAYOUT

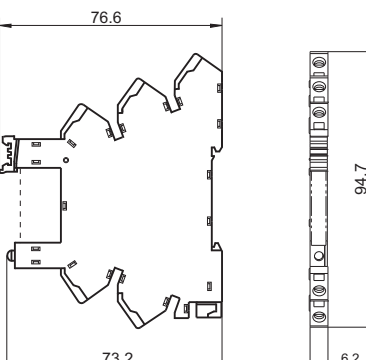
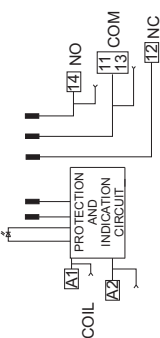
Unit: mm

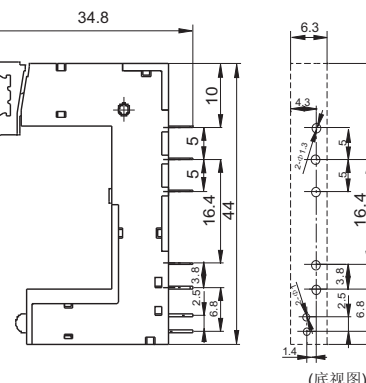
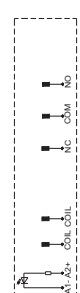
Socket	Outline Dimensions	Wiring Diagram	Accessory Available
<p>41F-1Z-C2-1/2/3/4/5</p>  <p>Screw terminal, DIN rail mounting, With finger protection device Certified by VDE and UL/CUL</p>	 <p style="text-align: center;">(Top View)</p>		<p>*marker 41F-M 41F-M1</p> <p>*jumper 41F-J1(blue) 41F-J1R(red) 41F-J1B(black)</p> <p>*separator 41F-S</p>
<p>41F-1Z-C4-1/2/3/4/5</p>  <p>Spring-loaded terminal, DIN rail mounting, With finger protection device</p>			<p>*marker 41F-M 41F-M1</p> <p>*jumper 41F-J1(blue) 41F-J1R(red) 41F-J1B(black)</p> <p>*separator 41F-S</p>
<p>41F-1Z-A2-1/2</p>  <p>PCB terminal, PCB mounting</p>	 <p style="text-align: center;">(底视图)</p>		<p>*marker 41F-M</p>

**Notes:** \* If need accessory, please order with type.

## DIMENSION OF RELATED ACCESSORY (AVAILABLE)

Unit: mm

### Marker

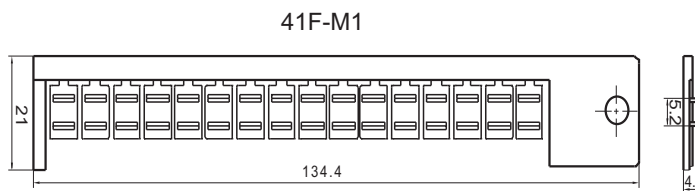
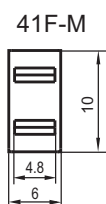

## DIMENSION OF RELATED ACCESSORY (AVAILABLE)

Unit: mm

### Jumper

41F-J1(blue)、41F-J1R(red)、41F-J1B(black)

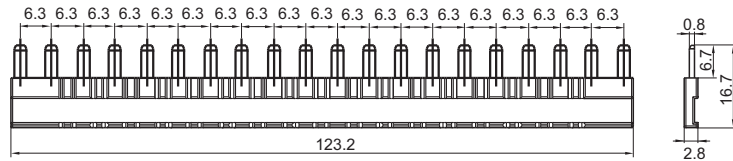

### Separator

41F-S



#### Things to be noticed when selecting sockets:

1. Please choose suitable relay socket according to the actual mounting environment, relay contact poles and terminal layout. If there is any query on selection, please contact Hongfa for the technical service.
2. As for related components, they should be selected separately. Please do give clear indication of the types of relay sockets and related components you choose while placing order.
3. Main outline dimension(L, W, H)  $\geq 50$ mm, tolerance should be  $\pm 1$ mm; outline dimension  $> 20$ mm and  $< 50$ mm, tolerance should be  $\pm 0.5$ mm; outline dimension  $\leq 20$ mm, tolerance should be  $\pm 0.3$ mm.
4. DIN rail mounting: recommend to use standard rail  $35 \times 7.5 \times 1$ ,  $35 \times 15 \times 1$ .

#### Disclaimer

The specification is for reference only. See to "Terminology and Guidelines" for more information. Specifications subject to change without notice. We could not evaluate all the performance and all the parameters for every possible application. Thus the user should be in a right position to choose the suitable product for their own application. If there is any query, please contact Hongfa for the technical service. However, it is the user's responsibility to determine which product should be used only.

## Precautions For Use

1. Please use the quick-break fuse with rating of 15Amp. for short-circuit protection.
2. It may cause failure, fire or malfunction, when the sockets is continuously applied the power to for a long term In case of exceeding the upper limit ambient temperature. So please ensure that the ambient temperature is within the upper limit when using sockets.

Operating temperature upper limit: 55°C: 41F-1Z-C2-3/4  
41F-1Z-C4-3/4

Operating temperature upper limit: 70°C: 41F-1Z-C2-1/2/5  
41F-1Z-C4-1/2/5

3. Things to be noticed when selecting soft wiring.

1) 41F-1Z-C2-1/2/3/4/5

The soft wiring can be divided into the following types.

- Twisted line or single wire below 2.5mm<sup>2</sup> or below AGW14.
- Within 2 roots when the twisted below 1.5mm<sup>2</sup> or below AGW16.

Be sure to use this size that the front end of the wire needs to be stripped of the 7mm~8mm insulation protection layer. (Figure 1)

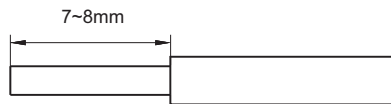

Figure 1

- Use the recommended screwdriver specifications when wiring.  
Plus driver: Shaft Diameter - 3.5mm.  
Single driver: Figure 2.
- Recommended tightening torque: 0.5N·m

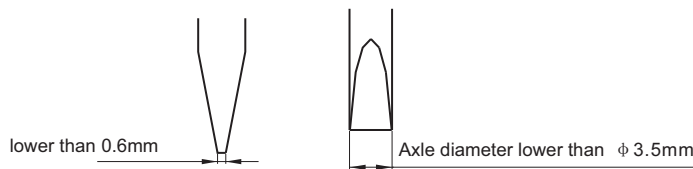

Figure 2.

b) 41F-1Z-C4-1/2/3/4/5

The soft wiring can be divided into the following types.

Twisted line or single wire greater than 0.5mm<sup>2</sup> or less than 2.5mm<sup>2</sup> or greater than AWG 20 and less than AWG14.

Be sure to use this size that the front end of the wire needs to be stripped of the 7mm~8mm insulation protection layer.

Use the recommended screwdriver specifications when wiring.

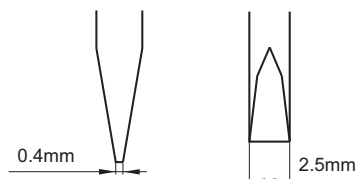

Figure 3.

## Precautions For Use

The insertion position of the wire and the screwdriver and the insertion direction of the screwdriver are as shown in Figure 4.

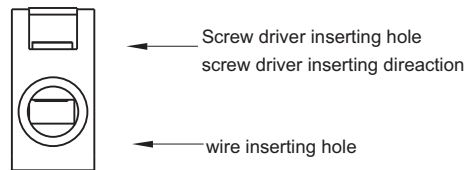

Figure 4

Please use cold pressed terminals when selecting twisted line.

The method of Wiring as shown in figure 5.

Step 1. Insert screwdriver into socket with screwdriver patchhole.

Step 2. Push the screwdriver in until it touches the stop position inside the socket, and keep the screwdriver in this position.

Step 3. Please keep the screwdriver in this position, and wires inserted into the terminal insertion hole bottom.

Step 4. Pull out the screwdriver and the wiring is completed.

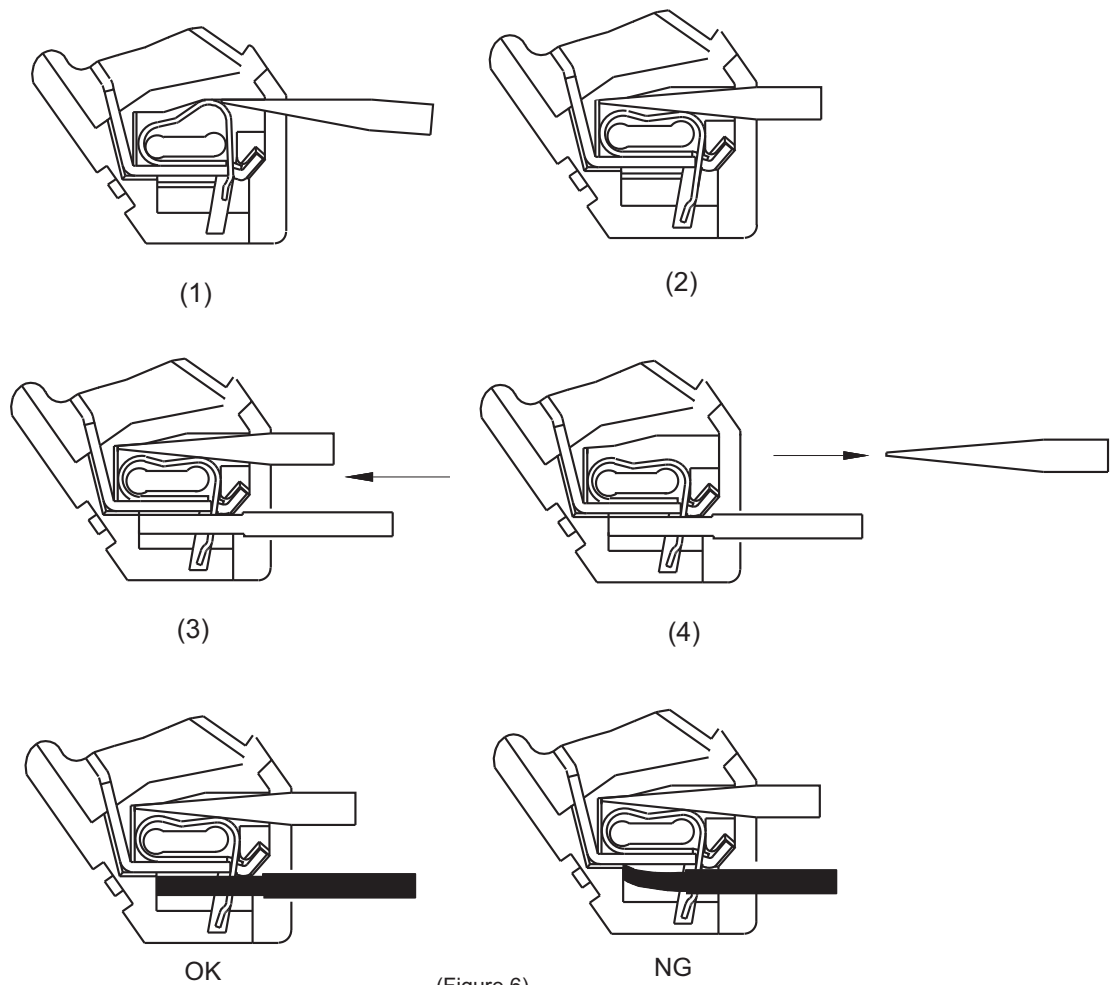

(Figure 6)

Do not insert the wire insulation.

## Precautions For Use

### 4. Mounting relay.

Presents the socket anti-stripping spring in an open state (see Figure 7), and aligns the relay to the main socket cavity (Figure 8). Then turn the buckle counterclockwise and press the relay gently until it is fully plugged into the socket (Figure 9).

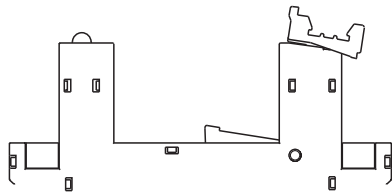

Figure 7

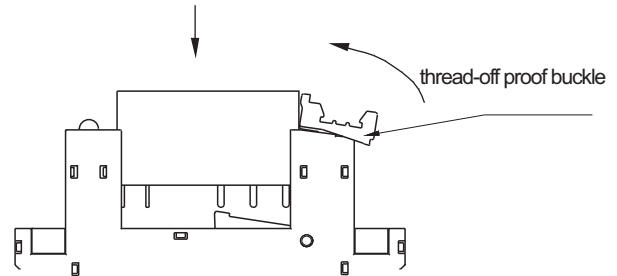

Figure 8

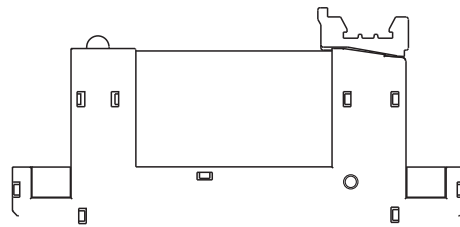
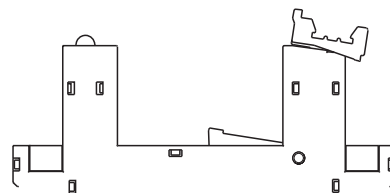
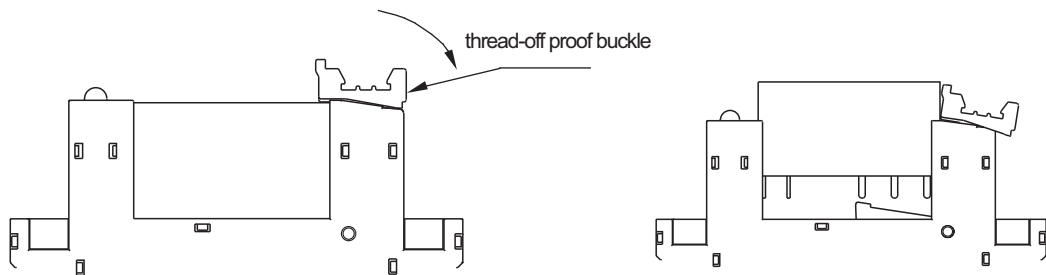

Figure 9

### 5. Disassembly relay.

Disconnect the relay by pulling the anti lock buckle of the socket clockwise (please refer to the pictures attached for more details)



## Precautions For Use

### 6. Installation socket.

Insert the A of the socket into the rail and press it in the direction of the arrow.(Figure 11)

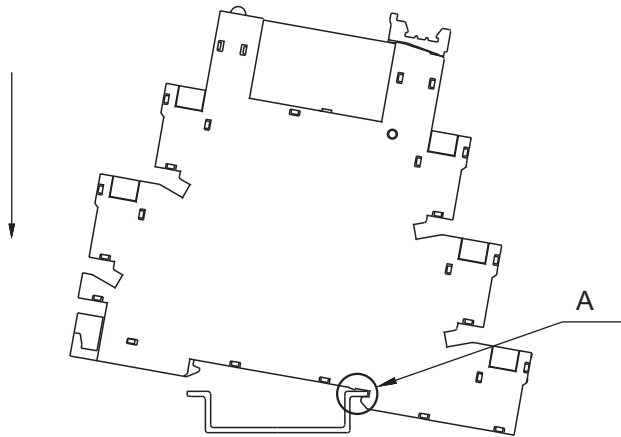

Figure 11

### 7. Disassembly socket.

Insert a screwdriver into B, turn in the direction of the arrow, lift the socket and remove the socket.(Figure 12)

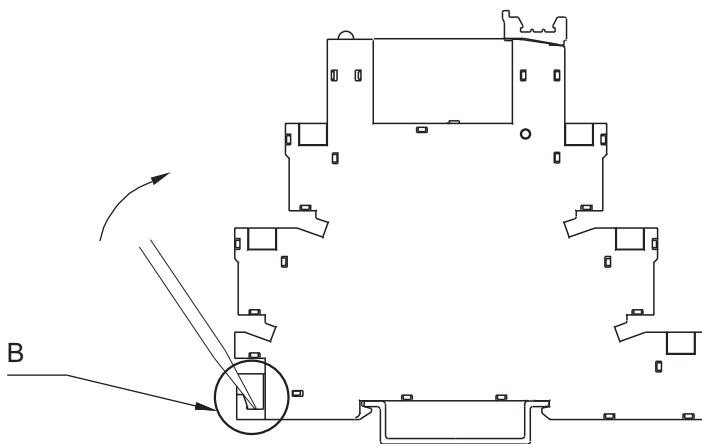

Figure 11

## Disclaimer

The specification is for reference only. See to "Terminology and Guidelines" for more information. Specifications subject to change without notice. We could not evaluate all the performance and all the parameters for every possible application. Thus the user should be in a right position to choose the suitable product for their own application. If there is any query, please contact Hongfa for the technical service. However, it is the user's responsibility to determine which product should be used only.

© Xiamen Hongfa Electroacoustic Co., Ltd. All rights of Hongfa are reserved.